

Signature by VingCard

Traditional locks

Where design integrity is top priority, there is a desire for the necessary hardware to blend into the interior, thus becoming virtually invisible to the end-user.

We have complemented our Signature by VingCard locks with high quality traditional locks to exactly match the style and finish of any Signature by VingCard lock, ensuring a uniform and sophisticated style throughout your property.



FEATURES:

- For aesthetic appeal, our traditional locks provide a uniform look throughout the property from main entry to bathrooms.
- Conforms to or exceeds the toughest building codes.
- Materials and finish; Satin Chrome, Satin Brass, Polished Chrome and Polished Brass.
- Suitable for storage room-, closet-, passage-, interconnecting-, bathroom doors and more.

Signature 1000 series

Signature 1000-series is available with EURO, ANSI DB (deadbolt below) and ANSI DA (deadbolt above) lock cases. It comes with the same handles as Signature electronic locks and in the finishes Satin Brass, Satin Chrome, Polished Brass and Satin Chrome to perfectly match the guest room doors with the back of house locks.



1001

Doors that do not need to be locked. Latch bolt operated by handle from either side (no locking).

Application	Lock parts	Operating parts
Passage or closet door	Latch	Door handles

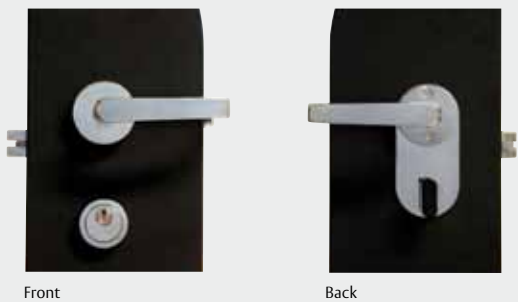

1021

Latch operated by handle from either side. Deadbolt operated by key from outside and thumbturn inside.

Application	Lock parts	Operating parts
Front exterior doors	Latch and deadbolt	Door handle, cylinder and thumbturn

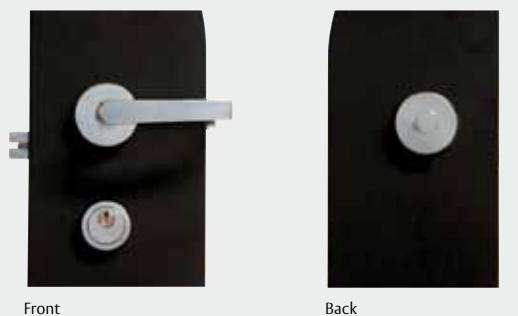

1021 Interconnecting

Latch operated by handle and deadbolt operated by key. Blind rose on the outside.

Application	Lock parts	Operating parts
Interconnecting doors	Latch and deadbolt	Door handle and cylinder

Signature Bathroom locks

VingCard also offer bathroom locks (565 and 2014 lockcase) that perfectly match the Signature guest room locks. It comes in the finishes Satin Brass, Satin Chrome, Polished Brass and Satin Chrome.



565



2014

Standard handles

Standard handles available are Wing, Functional, Gothic and Straight.

All handles are delivered in the same finish as the rose and indicator for a consistent and stylish look.



Wing

Functional

Gothic

Straight

Designer handles

For Signature 1000 there is also an optional Designers' Collection for an even wider choice of handles.

For more information, please see the Signature by VingCard brochure and contact your local sales representative. *(Note: Special terms and conditions apply).*



Quattro S

Otto G

GP Novantotto

NF Novantotto

RB Novantacinque

K1160

MDF Duemiladue

H120

S Novanta

AC Novantuno

H123

SPECIFICATIONS

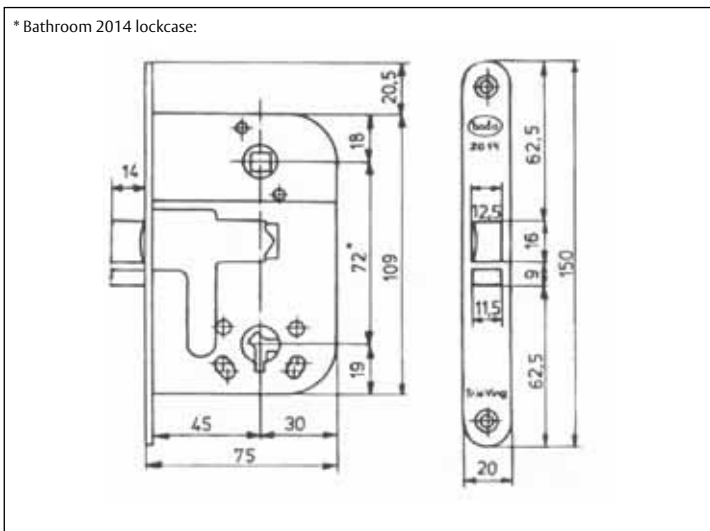
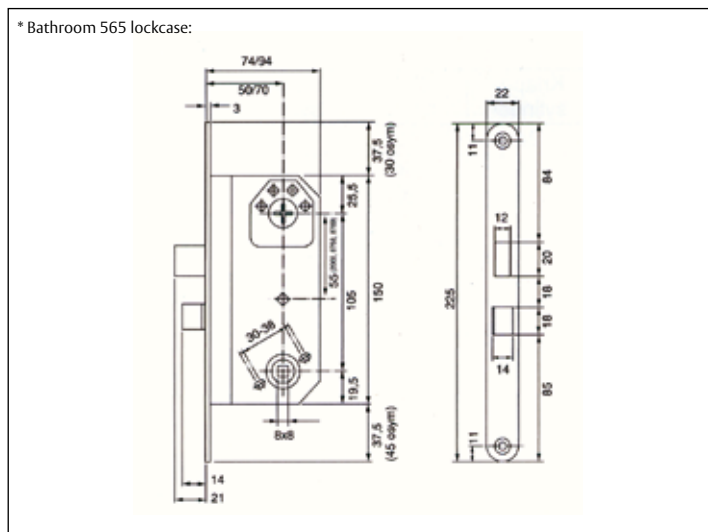
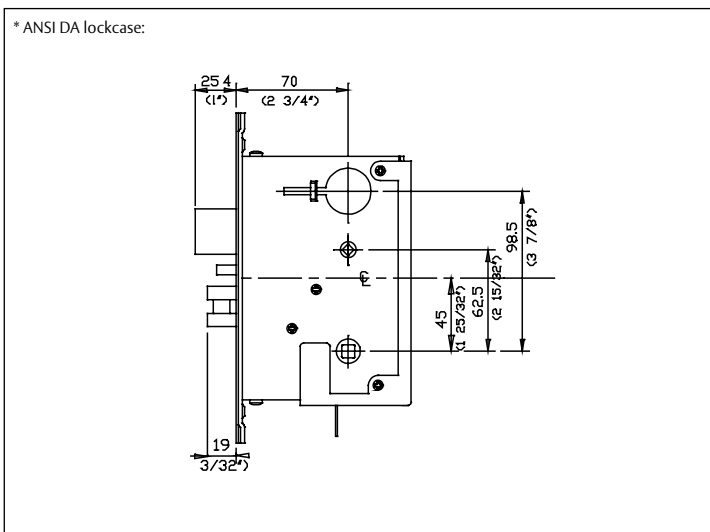
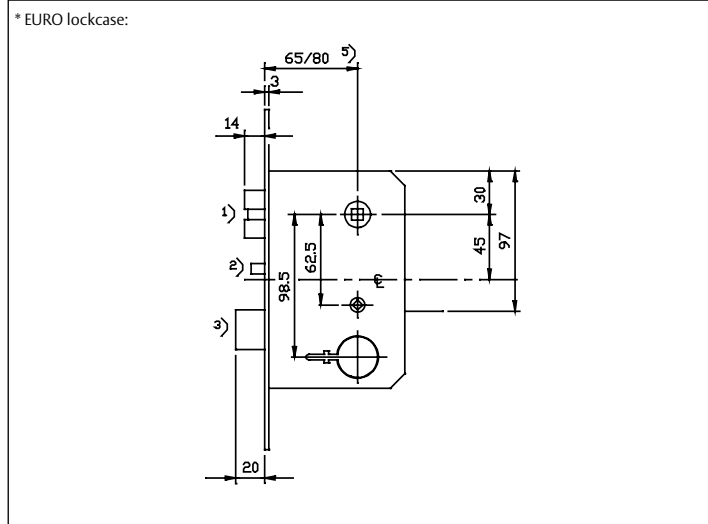
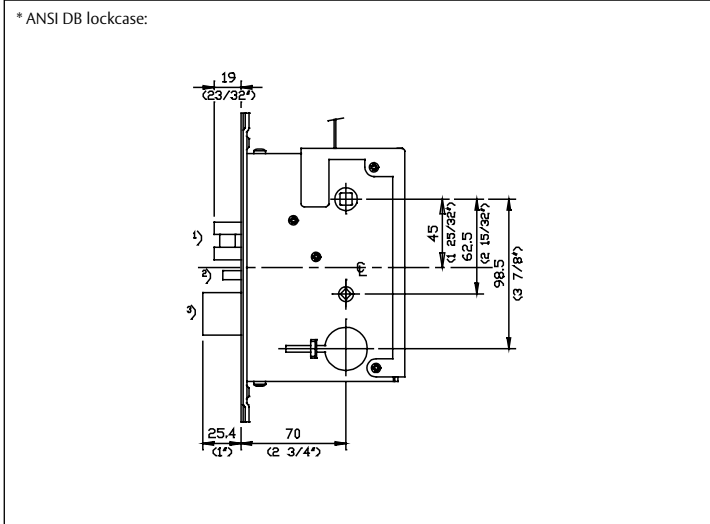

<p>ANSI:</p> <ul style="list-style-type: none"> • 25 mm front • 28 mm front • 32 mm front <p>Backset: 70 mm</p>	<p>EURO:</p> <ul style="list-style-type: none"> • 20 mm front • 22 mm front • 24 mm front <p>Backset: 65 mm</p>
---------------------------------------------------------------------------------------------------------------------------------------------------------	---------------------------------------------------------------------------------------------------------------------------------------------------------

Australian and Japanese lock case conforming to local standards.

Unlimited possibilities • customized solutions

Accessories
by VingCard®

Contact us:



ASSA ABLOY

VingCard Elsafe AS

P.O. Box 511 • 1522 Moss • Norway

Tel: +47 69 24 50 00 • Fax: +47 69 24 50 50

E-mail: info@vcegroup.com • www.vcegroup.com